

“KONZERT VI”

”mezzo-sopran”

Piece for 4 musicians, 1 Computer and 4 Speakers

Winfried Ritsch

23.November 1999 - May 9, 2000

The Microphon for the mezzo-sopran should be positioned not much farther than 10 cm in front of the mouth, if possible I suggest a headset. The voice is amplified through the speakers.

All sounds should be sung or almost spoken mostly silently. The phrases should be sung in blocks without break if possible.

The cents with the notes should indicate, that the pitch should be not exeat the tempered note, but a little higher or lower. The singer has a stop watch which is started synchron to with all others at time 0'00".

The pronunciation of the vocals is as in the english words.

a	up
ou	law
æ	at
ø	foot
ǔ	boot
ah	father
e	let
î	it
i	Eve

Table of Symbols

Timeline starts with 0'0" for synchronizing the stop watch

bow pressure:	very strong	strong	middle	few	none
note mode:	p.g!(first move of gliss.)	t =	gliss(glissandi)		
			<i>Tempi(Quarter = ...)</i>		
	Clefs for Notes		colors group notes to phrases with same tempo		
	omitted in score	Hallo Du	clef and meter for whole piece		
			+30		
			+30		
mezzo-sopran			ppp		Example for volume graph (cresc. - decr), use only if possible (eg. not on pizz.,etc.)

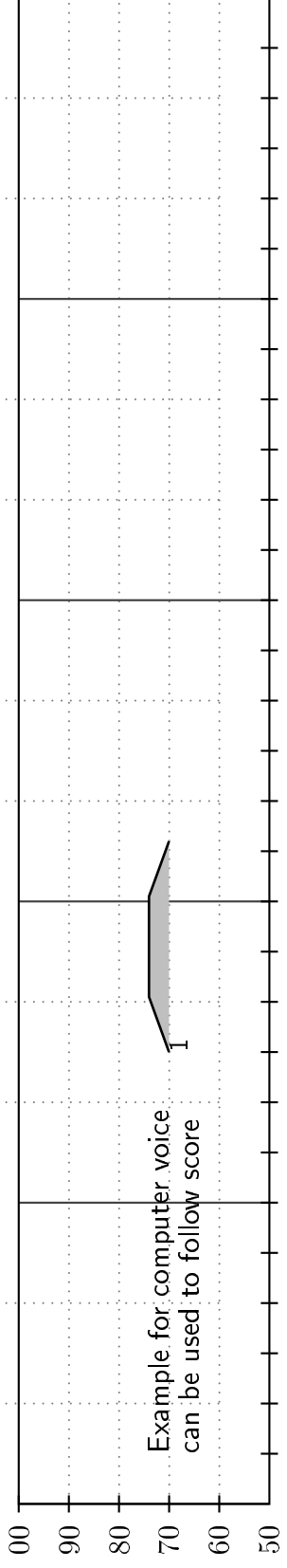

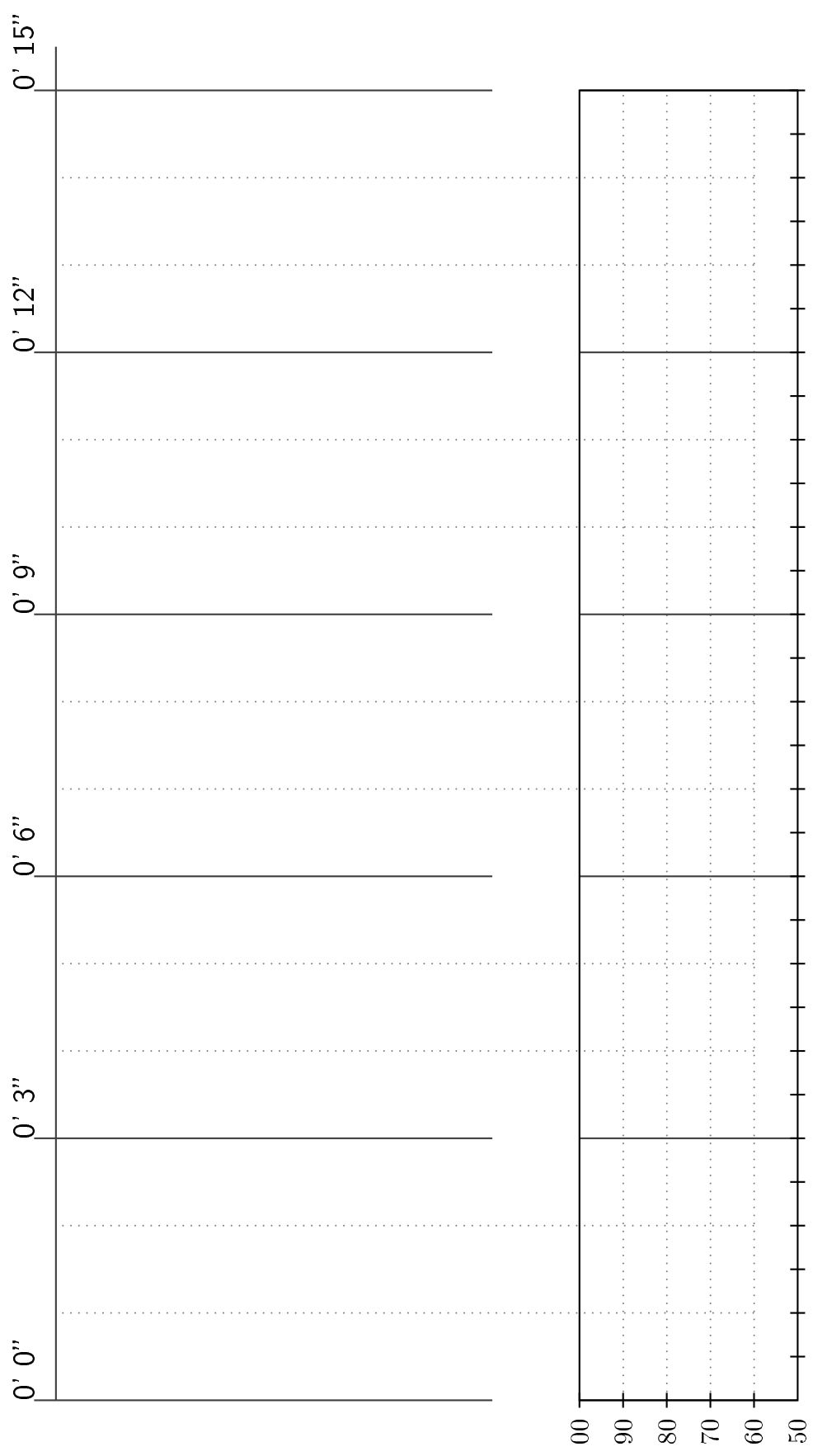

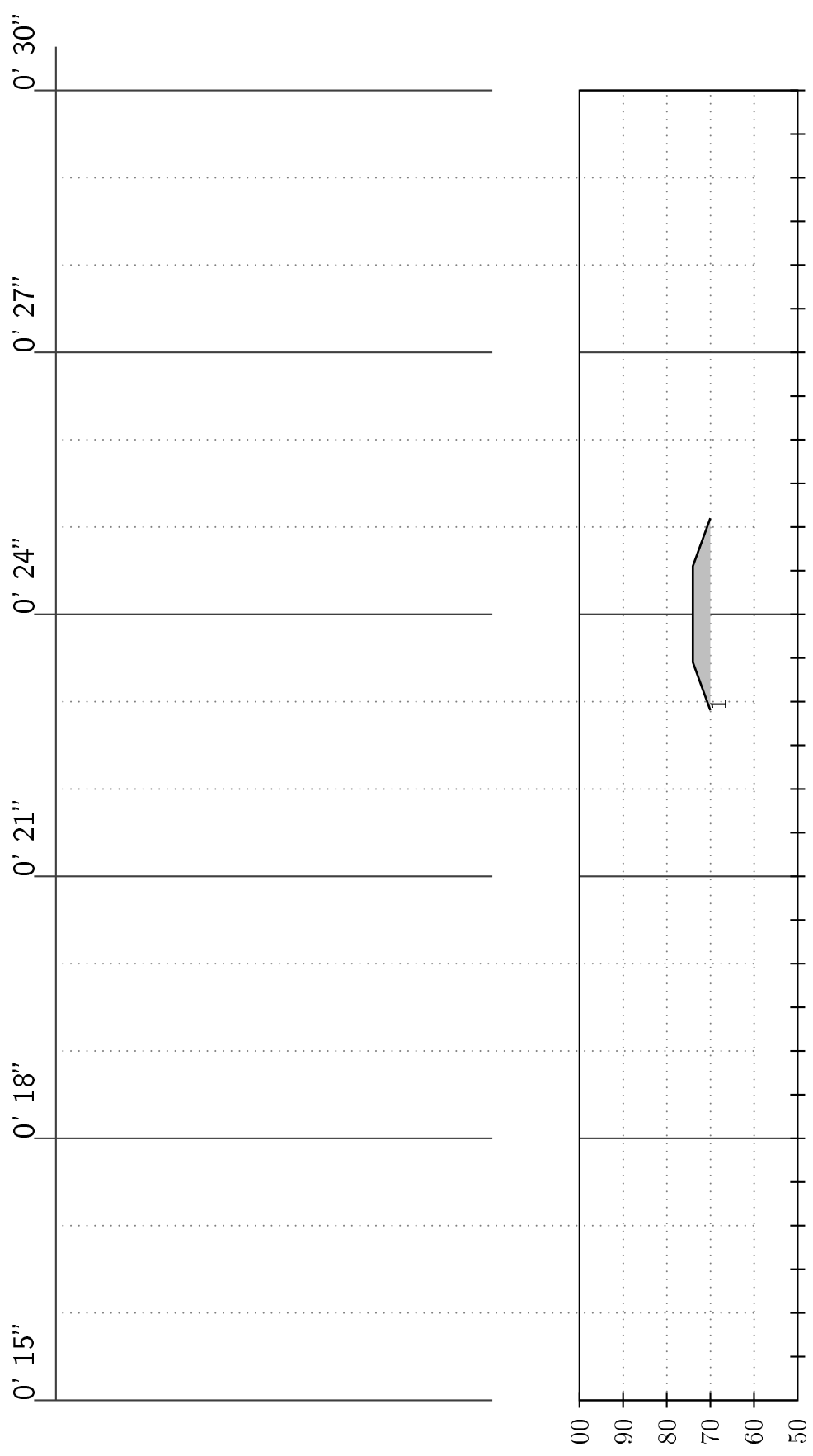

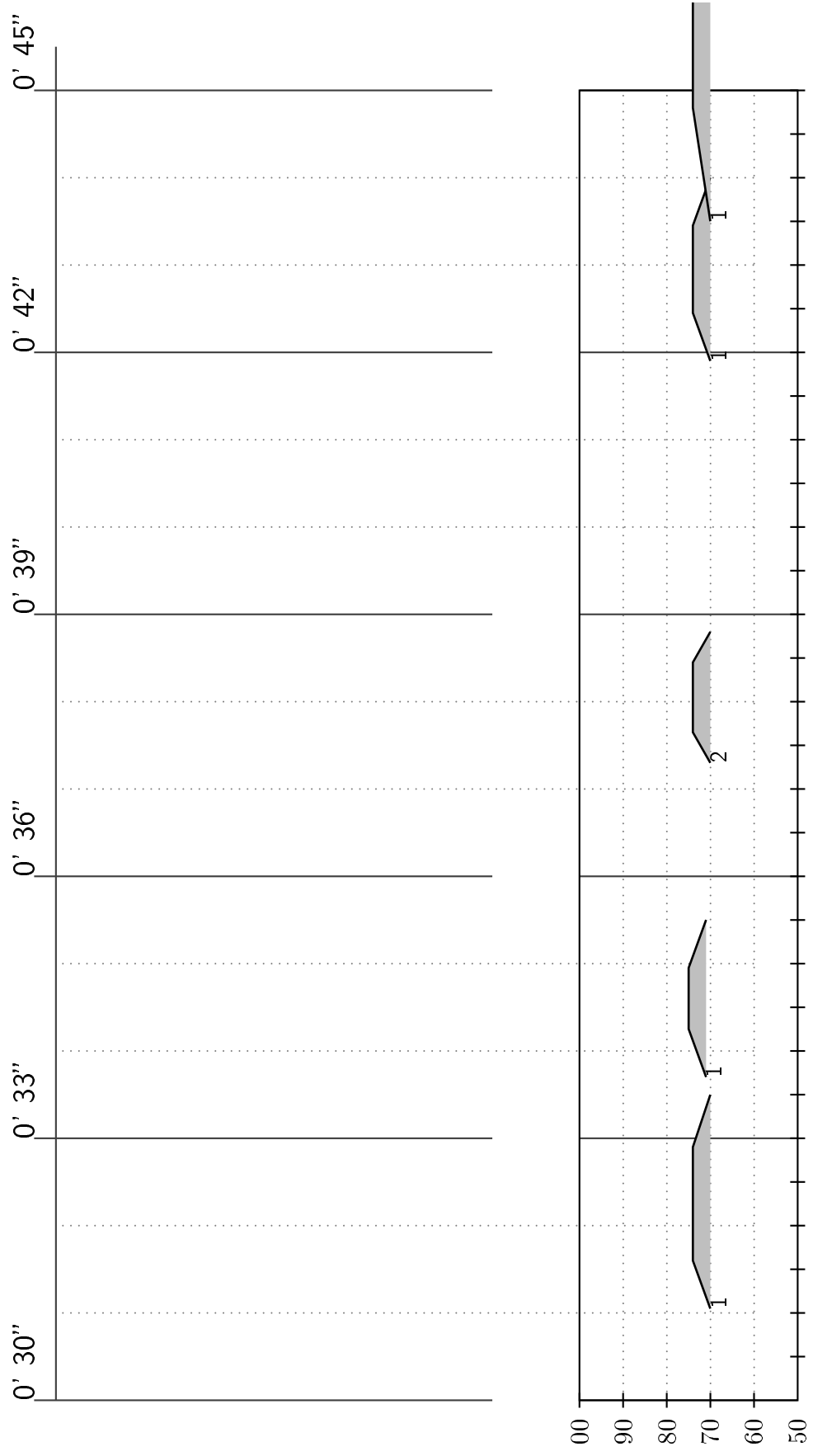

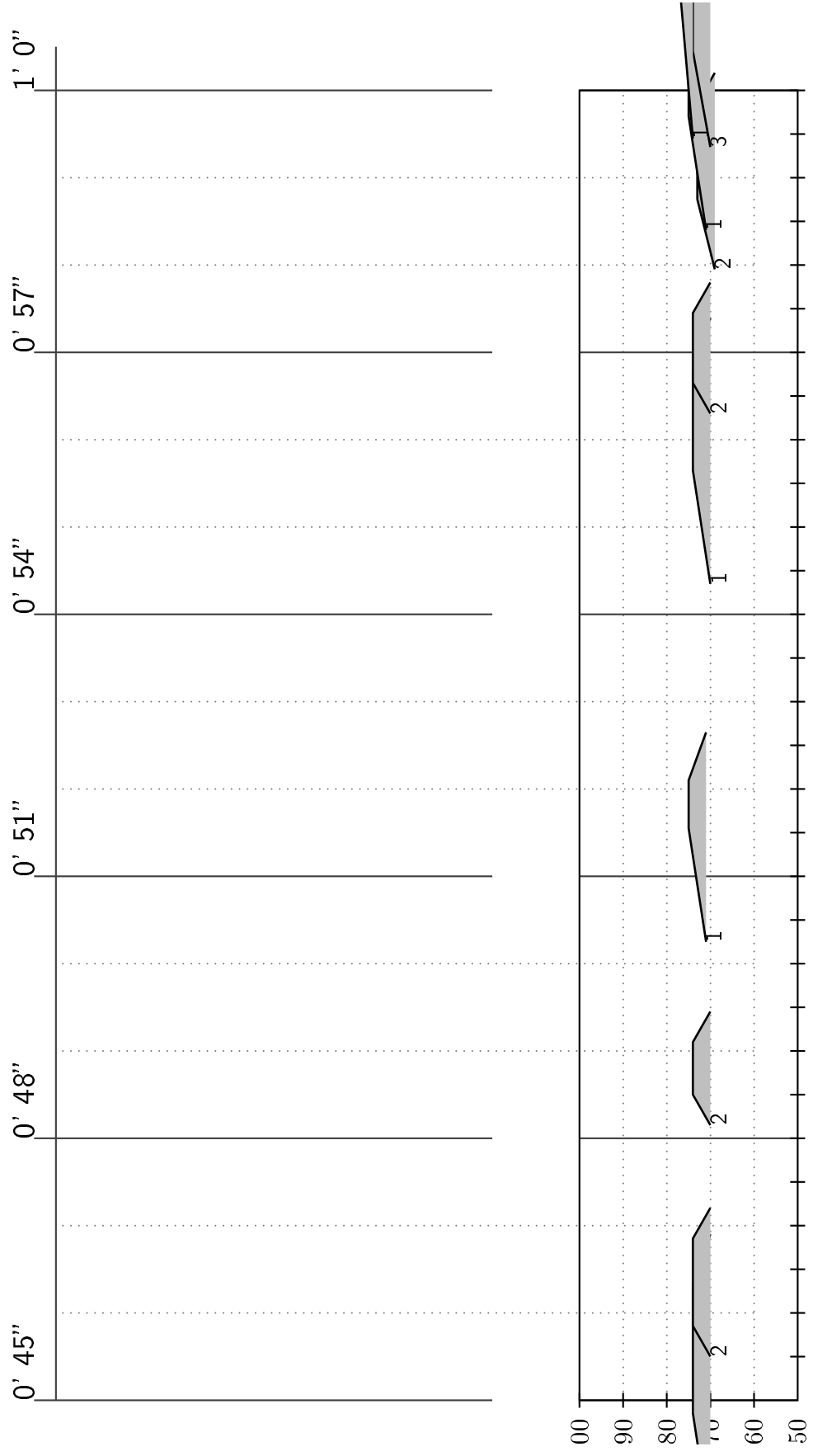

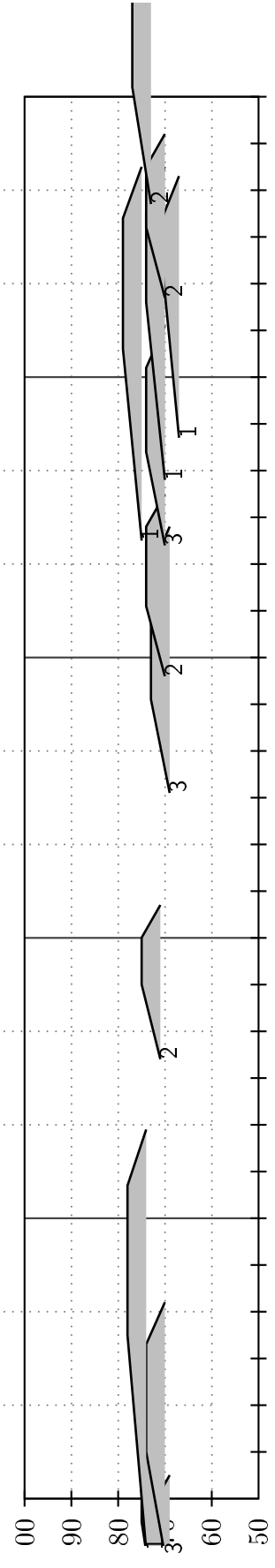
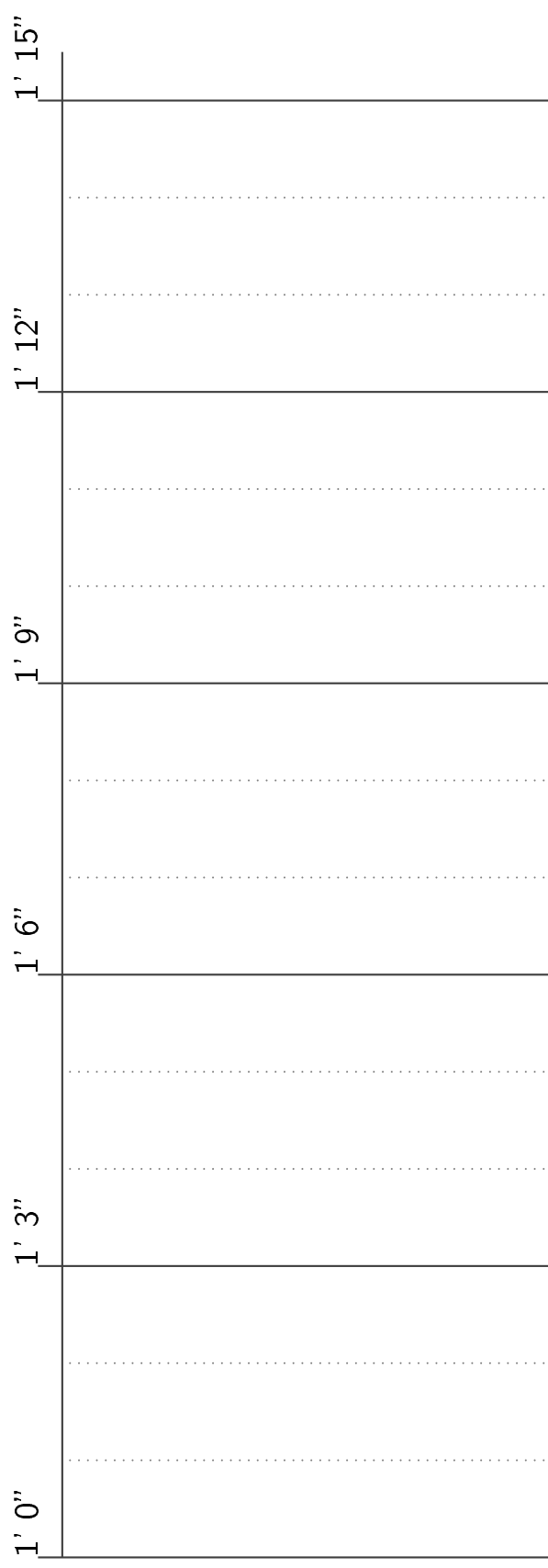

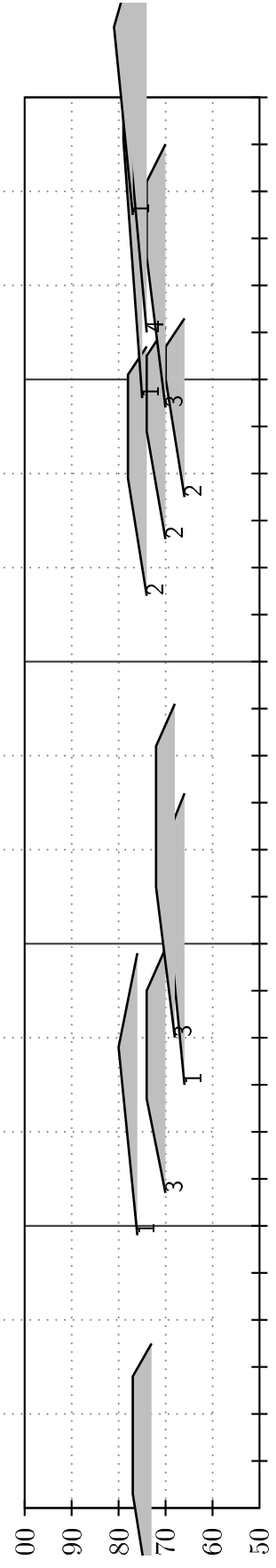
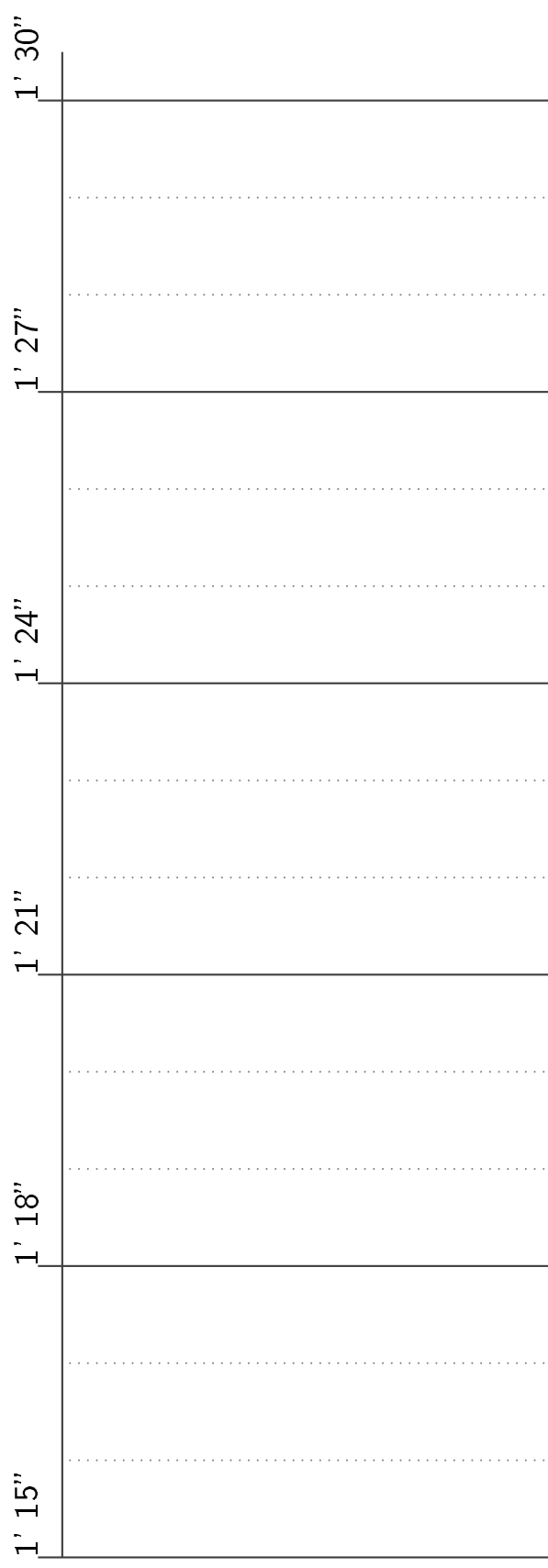

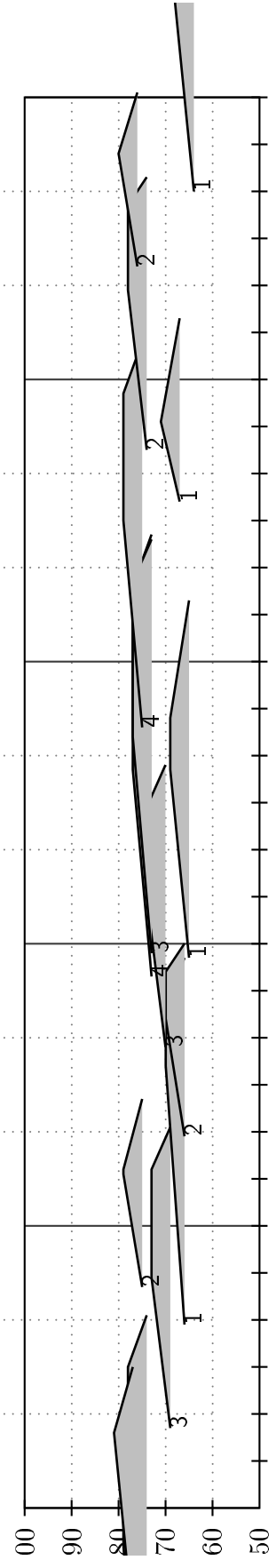
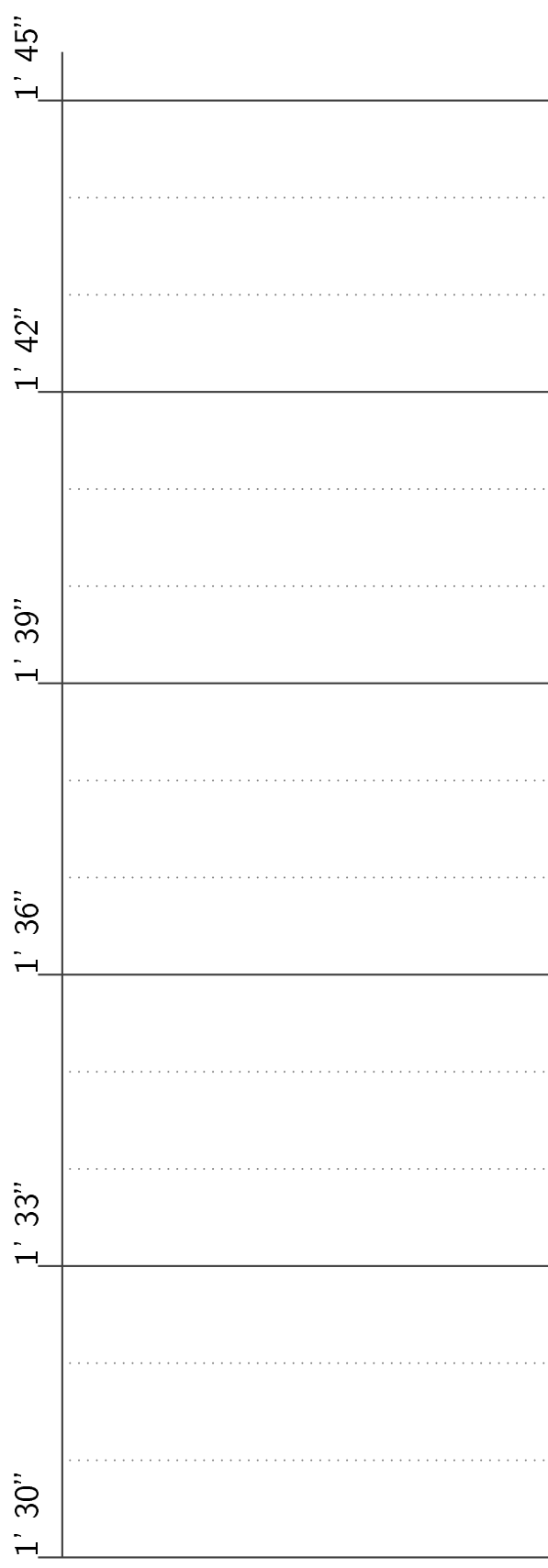

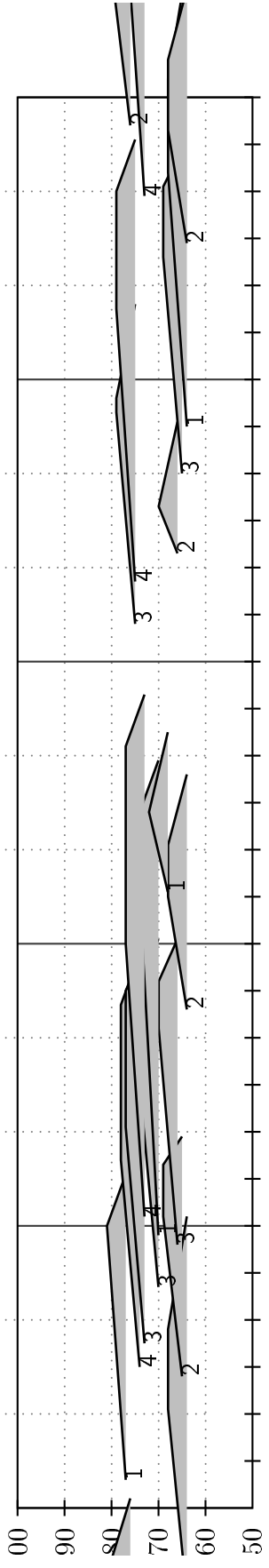
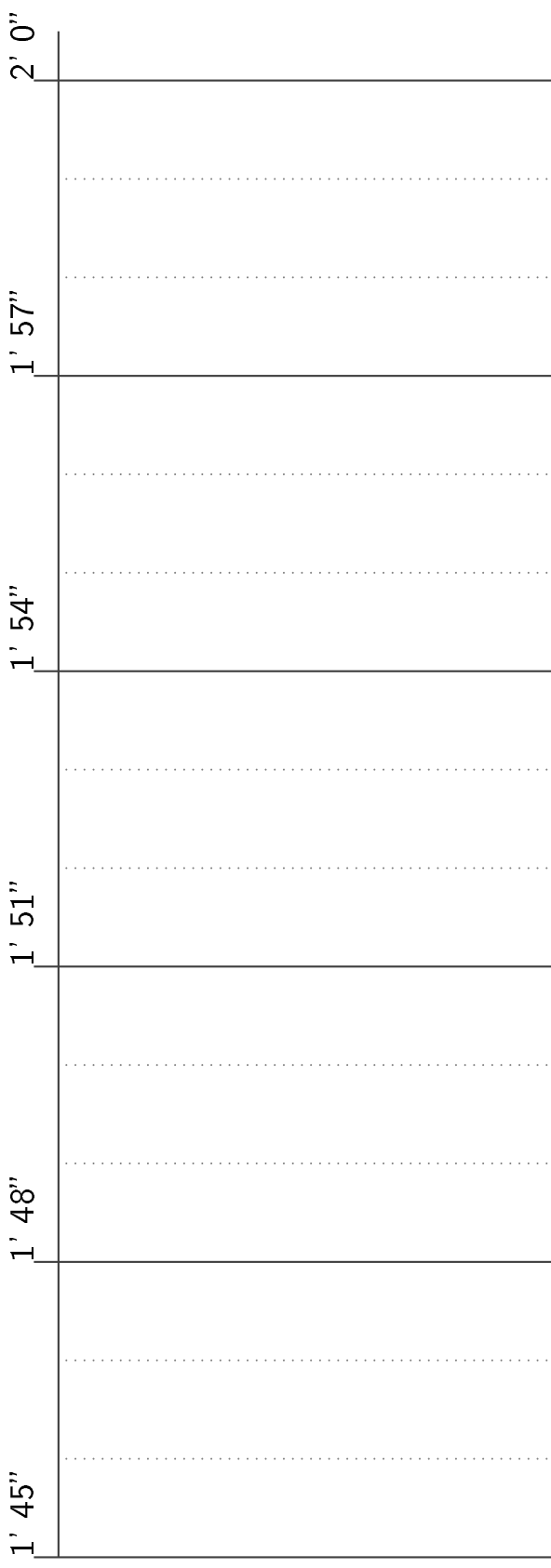

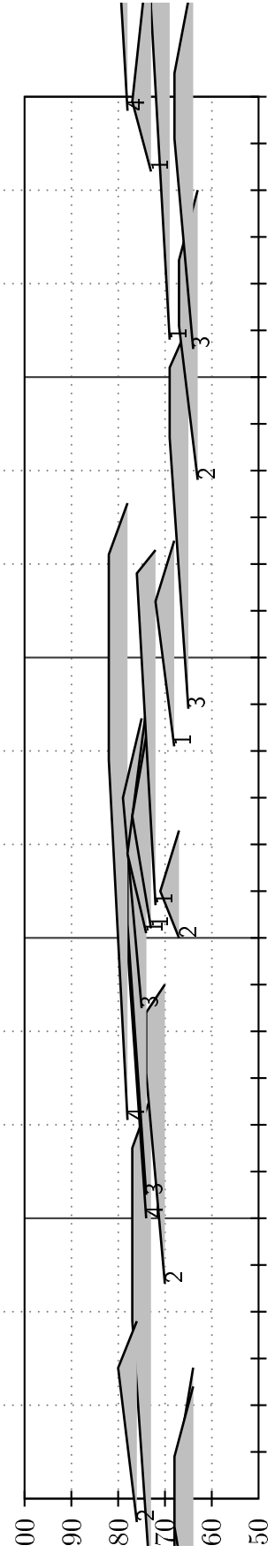
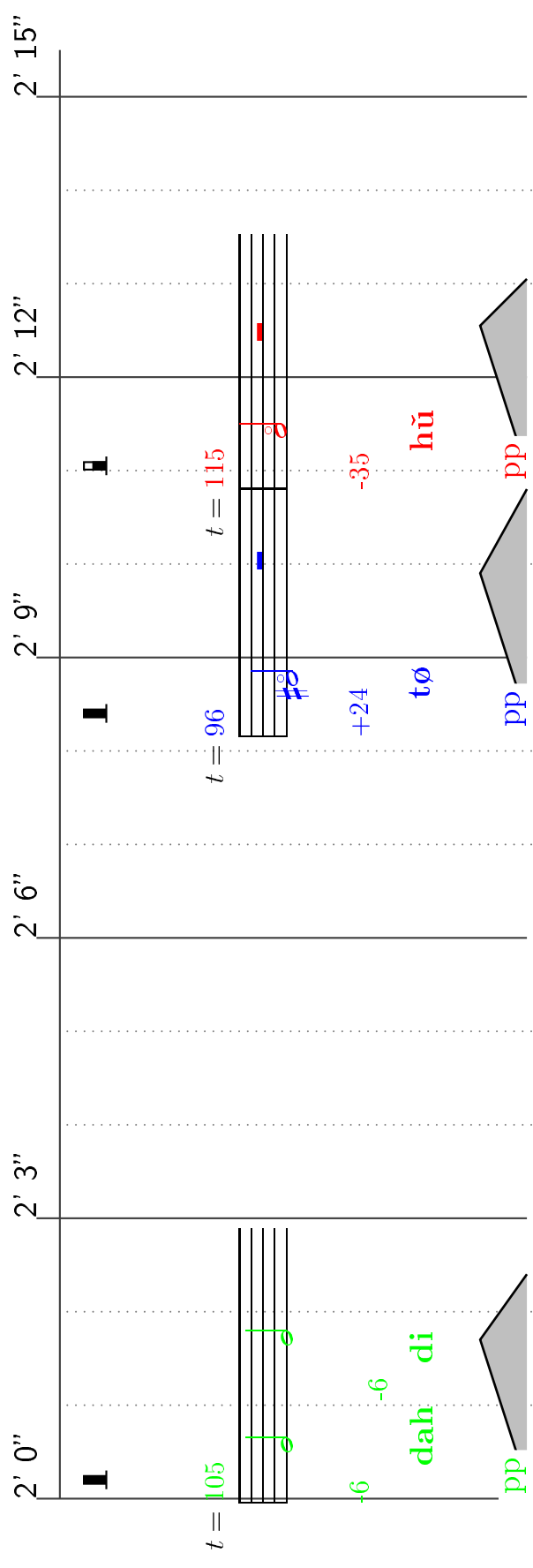

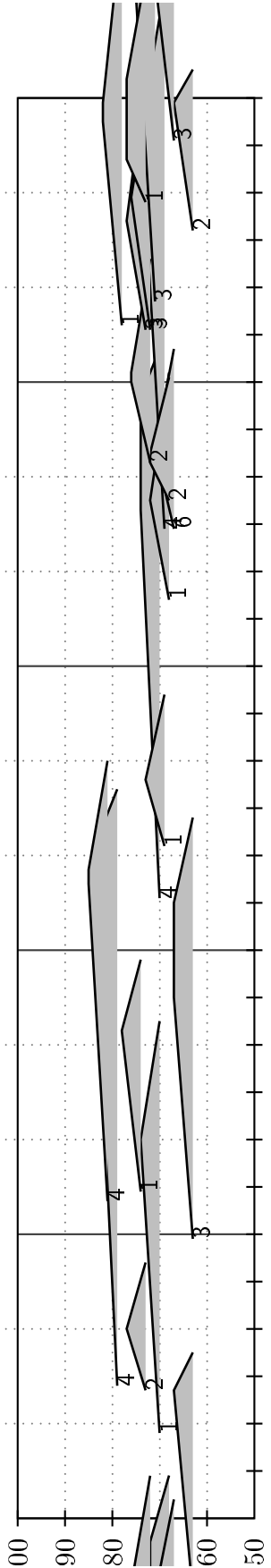
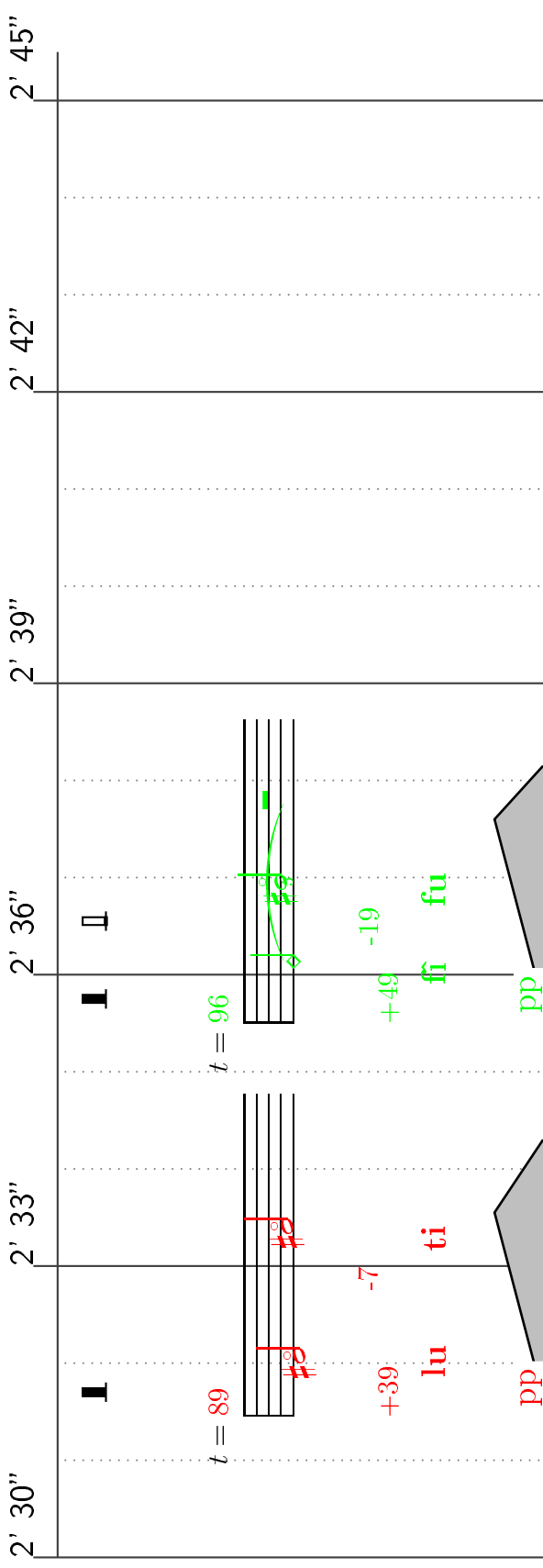

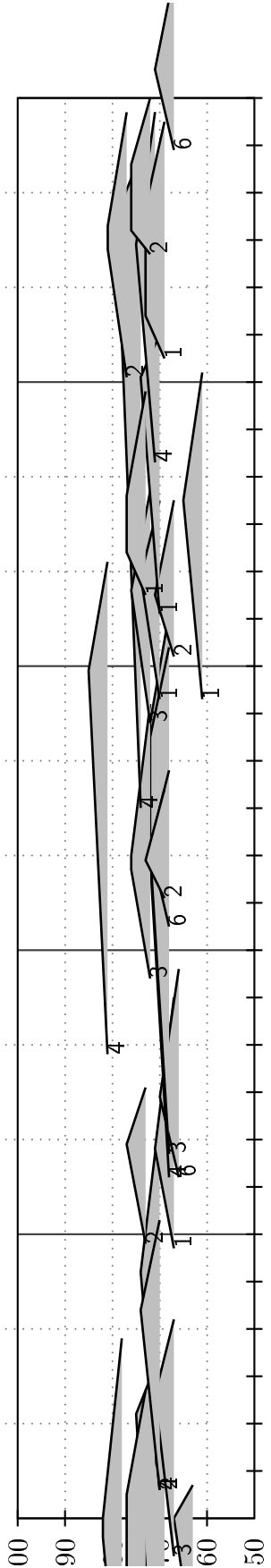
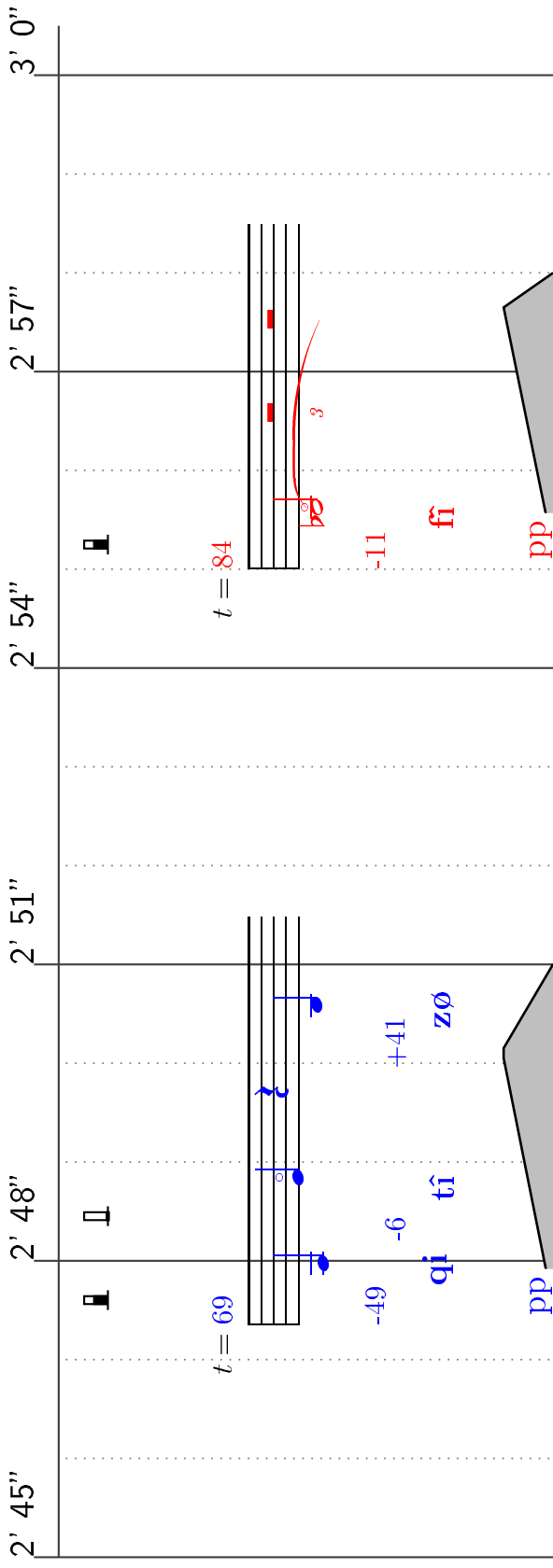

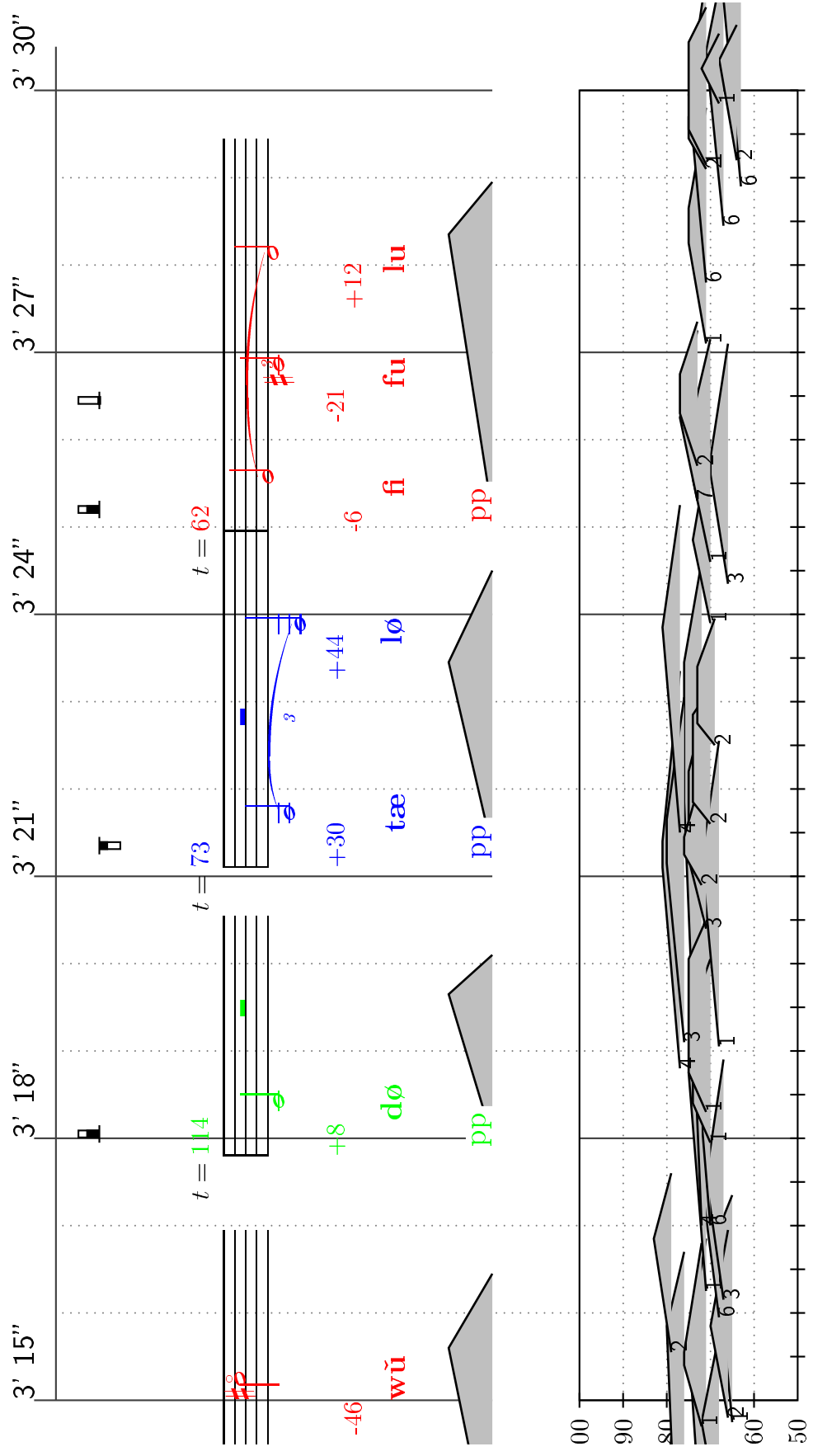

4' 0" 4' 3" 4' 6" 4' 9" 4' 12" 4' 15"

I **I** **I** **I** **I** **I**

p.gf. *p* *p* *p* *p* *pp*

t = 125 *t* = 97 *t* = 101 *t* = 136

-47 +23 +7 +7 +24 +14

li zu wah wah li dah

pp *p* *p* *p* *p* *pp*

3 3 3 3 3 3

#

3 3 3 3 3 3

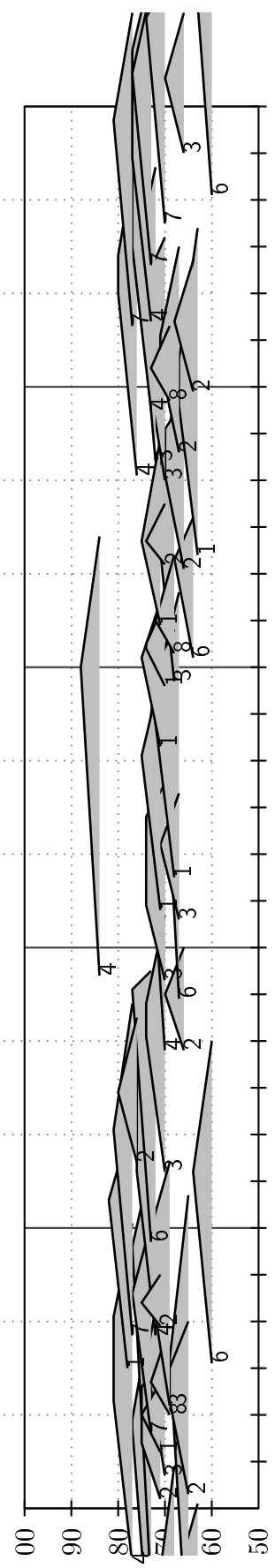

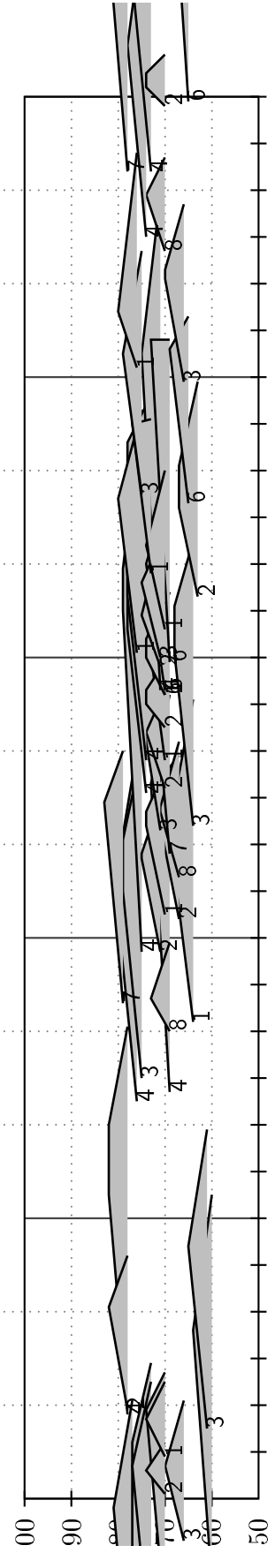
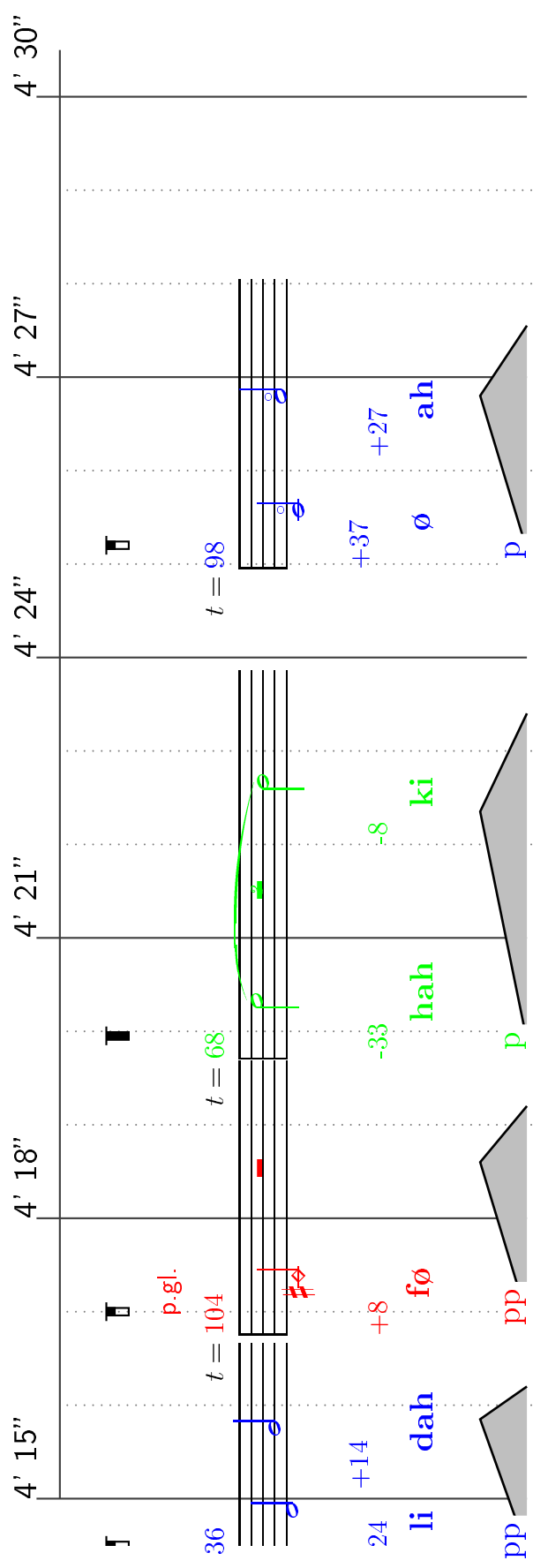

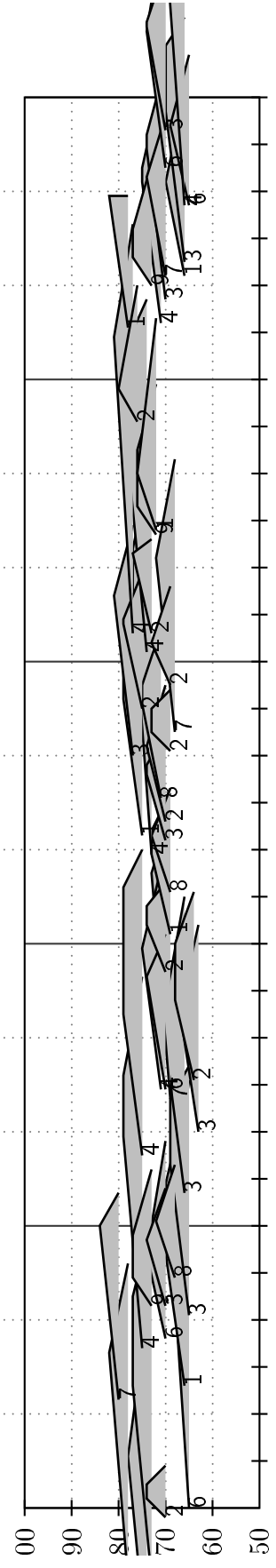
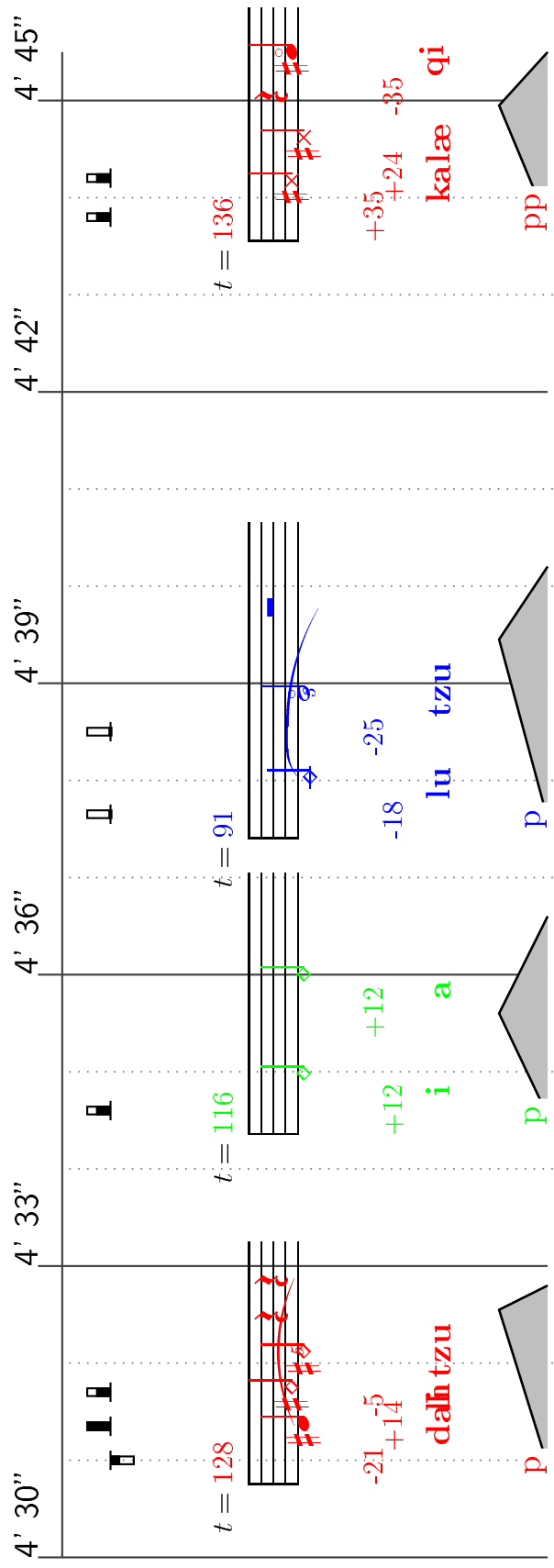

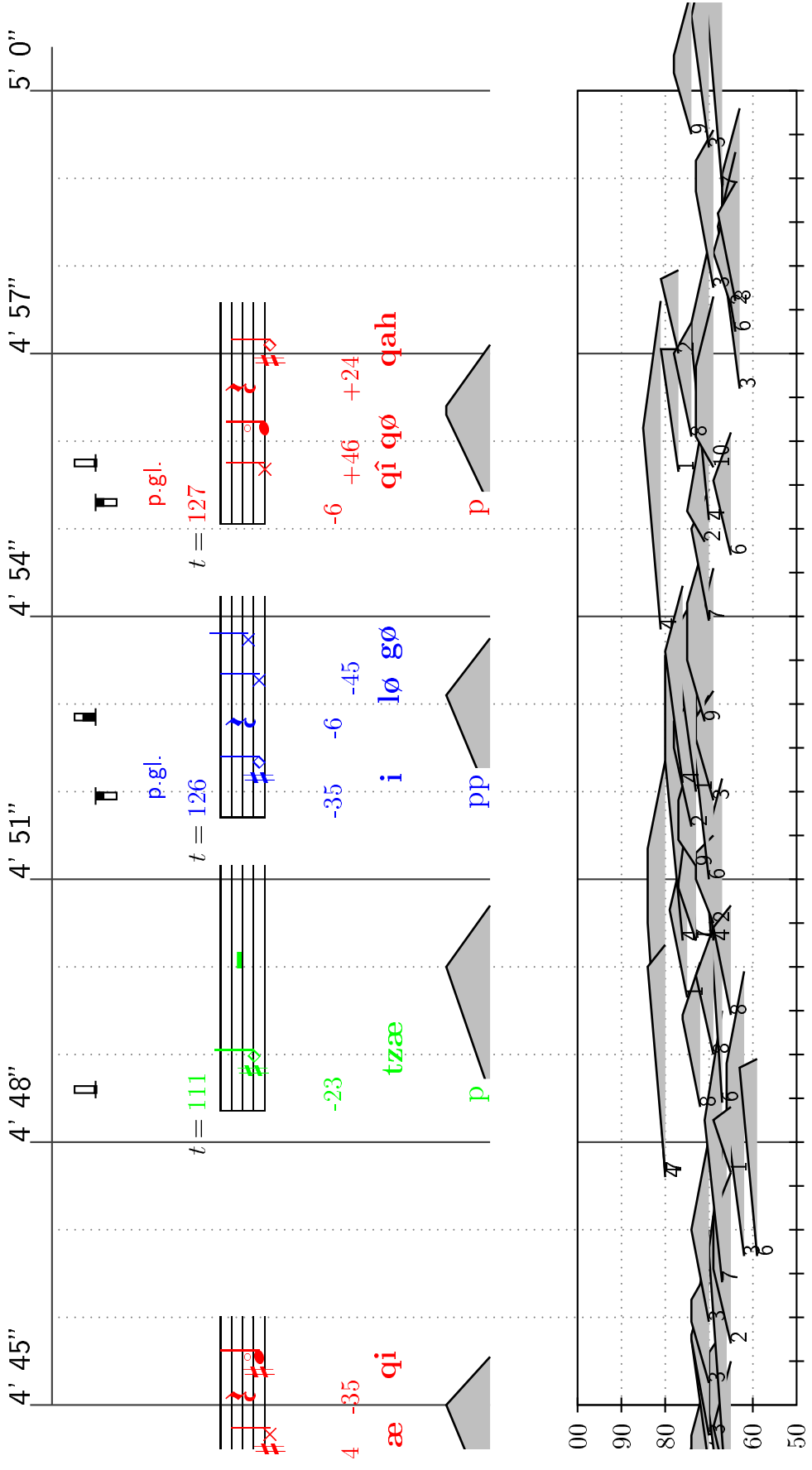

5' 0" 5' 3" 5' 6" 5' 9" 5' 12" 5' 15"

p.g.l.
t = 122
 -6 +38 +19
 nø qø ah
p

p.g.l.
t = 102
 +10 +24 +37
 qu qî lî
p

p.g.l. p.g.l.
t = 95
 -35 +49 +3 +40
 qî î zæ ou
p

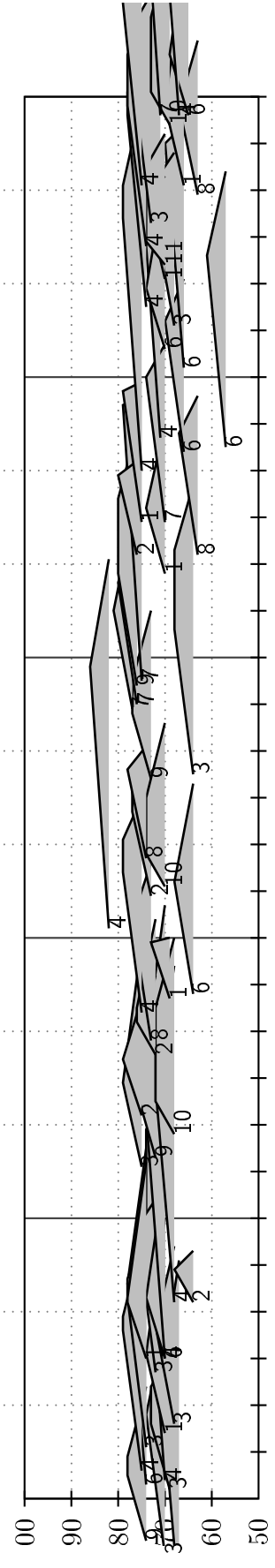

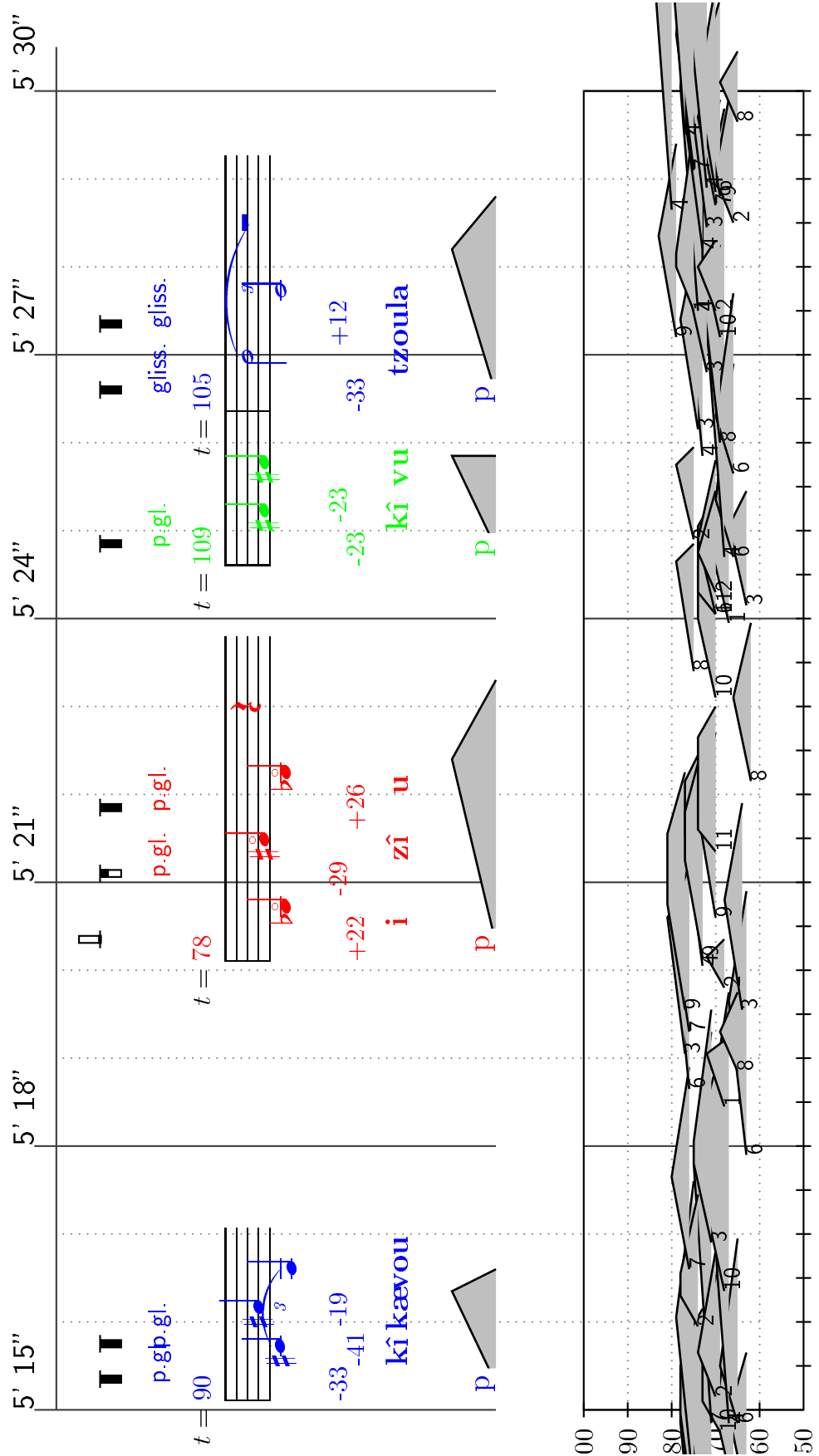

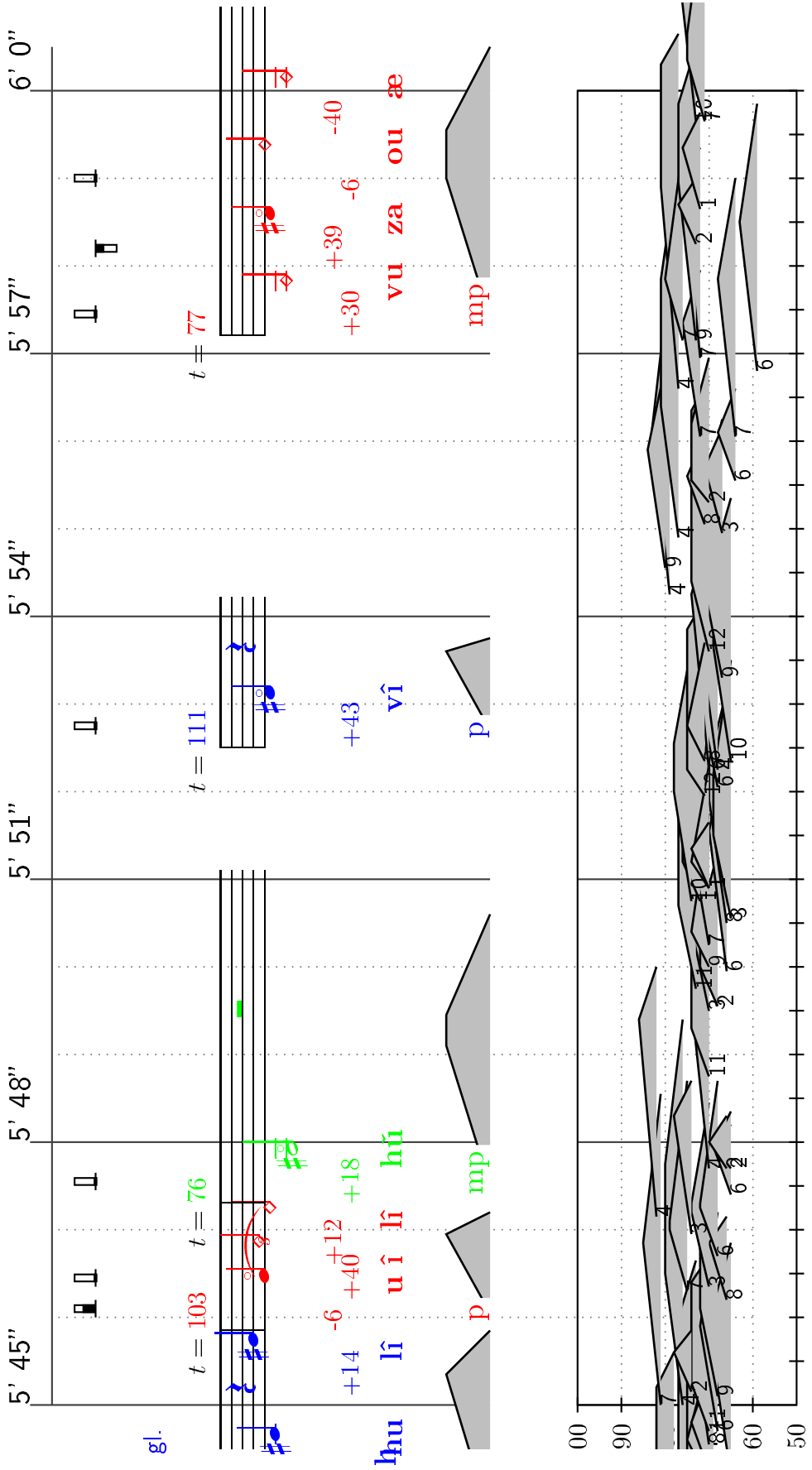

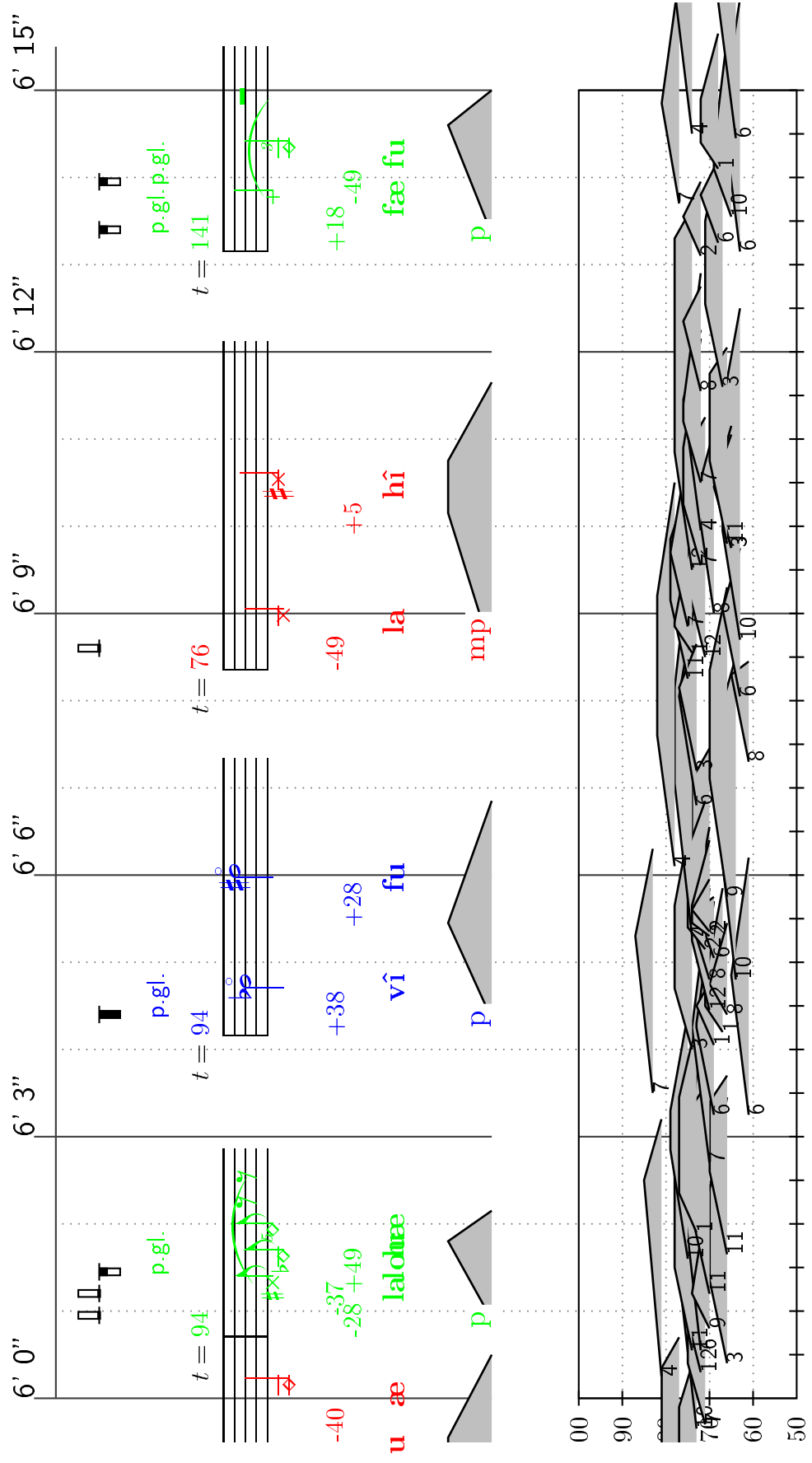

6' 15" 6' 30"

6' 18" 6' 27"

6' 21" 6' 24"

6' 24" 6' 30"

p.g.l.
t = 87
-2
qî u
p

t = 108
-48
fi
p

t = 116
+22 +10
u lø
mp

t = 102
+29
ah u
p

+19

